



1 System description

The control unit is used to measure the concentration of nitric oxide (NO) in exhaust gas. This measurement is used to calculate the amount of reactant to be injected upstream of the converter. As well as metering reactant the control unit also controls the supply of air. In addition, the control unit monitors certain safety-relevant process values (pressure, temperature) in and above the converter.

The complete visual display system is integrated in the PLC housed in the control unit. A switch facilitates gaining access within the same network as required. That makes it possible to operate the visual display system via the control panel or a notebook in the control room. SNQ standard SNQ with control panel

- ▶ Original language: German
- ▶ This section is a part of the documentation for the 'Exhaust gas purification system'. The chapter 'Foreword, Definition, Safety, Disposal' in Index 1 of the folder 'Exhaust gas purification system' must be observed.

Content

1	System description	1
2	Function	3
2.1	Measuring gas concentrations	3
2.2	Measurement sequence	3
3	Conditions	3
4	Assembly and installation	4
5	Commissioning	4
6	Operation and control	4
6.1	Using operating elements	4
6.1.1	On/Off button	4
6.1.2	Alarm/Reset button	4
6.2	User control via the visual display system	5
6.2.1	'Start' screen	5
6.2.2	'Overview' screen	6
6.2.3	'Dosage' screen	7
6.2.4	'Measurement system' screen	8
6.2.5	'Controller' screen	9
6.2.6	'Monitoring' screen	10
6.2.7	'History' screen (measured data log)	11
6.2.8	'Alarms' screen	12
6.2.9	'Fault log' screen (fault log)	12
6.2.10	'Parameters' screen	13
7	Servicing	18
7.1	Repair / replacement	18
7.1.1	Replacing the sample gas filter / scavenging air filter	18
7.1.2	Replacing the cooling air filter	18

2 Function

As soon as the exhaust gas generator goes into operation, the reactant nozzle is cooled. As soon as the prescribed/parameterized criteria are reached, reactant is injected. The table below lists the criteria:

Criteria for injecting reactant
Engine running
Smallest enabled load reached
Injection temperature reached
System in Automatic Mode
No faults

2.1 Measuring gas concentrations

Electrochemical measuring cells measure the concentration of gas.

The nitrogen oxide (NOx) level is calculated using the nitrogen monoxide measurement. This is a proven method of taking measurements instead of taking an NOx measurement, because the proportion of nitrogen dioxide (NO2) in most combustion gases is negligible (less than 5%).

2.2 Measurement sequence

The graphic below shows a measurement sequence for a period of 20 minutes..

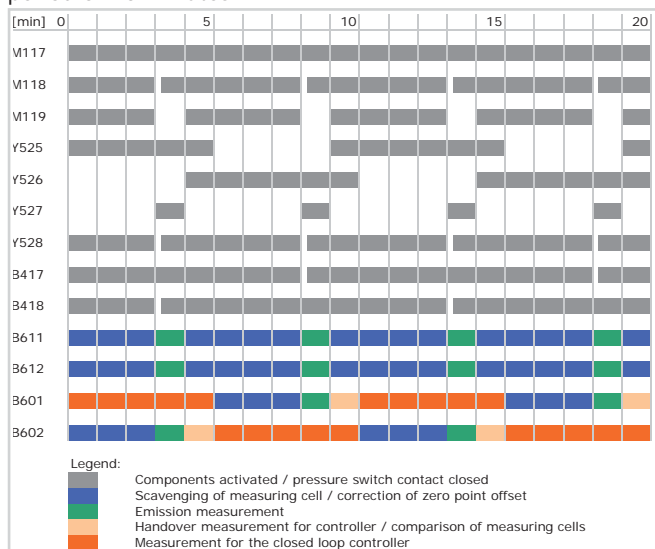

3 Conditions

If the operating temperature in the control unit cannot be maintained, an air-conditioning unit (option .acu) must be installed.

The operating conditions (operating temperature, degree of protection, electricity and compressed air consumption) are specified in the relevant data sheets. (→ [Data sheet](#))

All assembly and installation work must be carried out by qualified personnel only. Changes to products may only be made with prior written consent from Hug Engineering AG. Hug Engineering AG accepts no liability or claims under guarantee for damages resulting from improper installation work.

Exact information pertaining to the electrical installation must be obtained from the wiring diagram. Analogue signal cables must be shielded. They should be laid so that they are isolated and not parallel to live cables and components. The shielding of analogue signal cables must be earthed at one end. (→ [Wiring diagram](#))

4 Assembly and installation

200 mm space must remain free on the right-hand side to allow air to circulate and ventilate the cabinet.

5 Commissioning

Commissioning is carried out by Hug Engineering AG or an authorized partner. However, various preparatory measures must be taken in order to ensure efficient commissioning:

- Check the electrical installation and wiring of the components.
- Check the electric signals.
- Check the compressed air and reactant lines.
- The engine must be ready for operation.
- The engine cooling system must be ready for operation.

(→ [Maintenance Manual folder](#))

6 Operation and control

The exhaust gas purification system can be controlled via operating elements or a visual display system.

6.1 Using operating elements

As standard, two illuminated push-buttons are installed at the control unit for operation purposes.



6.1.1 On/Off button

Press the illuminated green push-button to turn the exhaust gas purification system on and off. The system will automatically inject reactant when the exhaust gas purification system is turned on and all conditions have been fulfilled.

LED	
Off	Exhaust gas purification system off
Flashing	Exhaust gas purification system on, conditions for injecting reactant not met
Permanently on	Injection in operation

6.1.2 Alarm/Reset button

The red illuminated push-button indicates faults. Fault alarms can be acknowledged by pressing the button.

LED	
Flashes 1x	Warning
Flashes 2x	Fault in measuring system
Flashes 3x	Injection fault
Flashes 4x	Test function active

6.2 User control via the visual display system

The complete exhaust gas purification system can be controlled via the visual display system. Parameters can be changed and current values and operating statuses are displayed in real-time. Faults are displayed in great detail.

User levels

User authorization is divided into four different password-protected user levels.

User level 0	
Application	- Set the language - Basic functions to operate the system - Display all measurement values and parameters
Description	- View all screens on the visual display system. - Turn the automatic mode on and off - Acknowledge faults

User level 1	
Application	- Not used
Description	-

User level 2	
Application	- Set dosing amounts - Set monitoring parameters
Description	The screens for the buttons 'Dosage, Controller and Monitoring' are enabled.

User level 3	
Application	- Set parameters - Configure the exhaust gas purification system
Description	The screens for the button: 'Parameters' are enabled.

6.2.1 'Start' screen

On the Start screen it is possible to make fundamental configuration settings for the visual display system. In the left-hand part of the screen it is possible to select any of the connected system components, as well as the pump controller.

The user language can be selected via the buttons in the middle of the screen.

At the top of the right section is the box for entering your password and the button for logging out.

Below this, you can see general information such as software versions and the system time (Coordinated universal time, UTC).

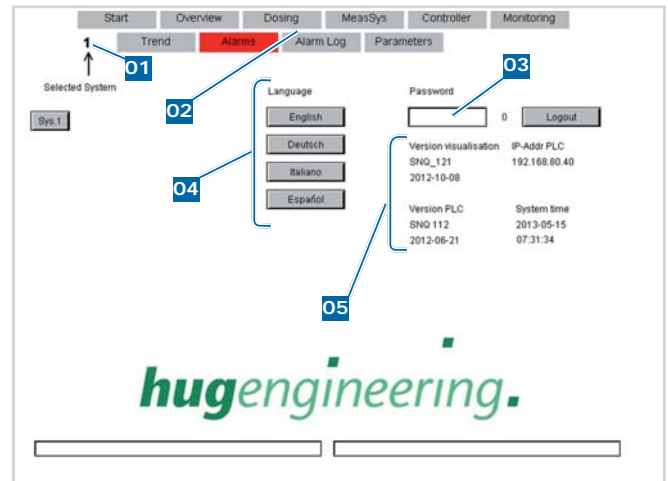

- 01 Selected system
- 02 Menu bar
- 03 Password entry field
- 04 Language selection
- 05 General information

6.2.2 'Overview' screen

The current values and operating statuses are displayed on this screen. In addition, the elapsed operating hours of the air supply/injection as well as the time to the next maintenance are also indicated.

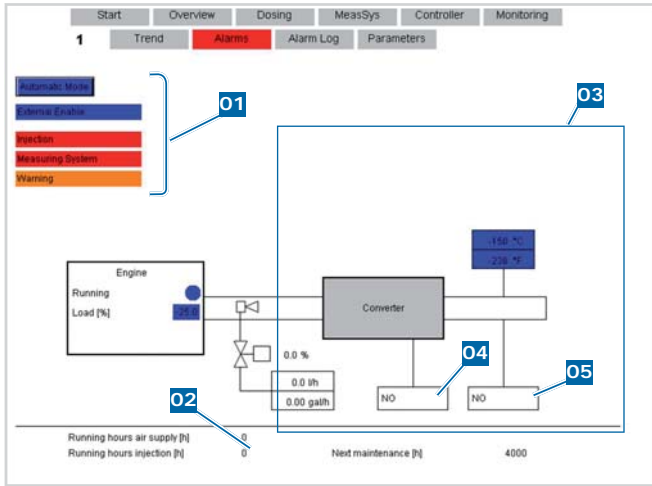

01 Statuses

02 Elapsed operating hours and maintenance

03 Measurements

04 Controller

05 Emissions

Fields highlighted blue mean either they are inactive or their setpoint values have not been reached.

Fields highlighted red mean that a fault has deactivated either the reactant injection process or the measurement system.

Fields are highlighted green when the respective value corresponds with the desired value.

The reactant injection process cannot be enabled if any of the fields are highlighted blue.

Automatic mode

Press the 'Automatic' button to turn the exhaust-gas purification system on and off.

External enable

The 'External enable' field indicates if the external enable has been activated or not.

Load curve 2 active

The 'Load curve 2 active' field indicates when the second of two possible load curves is selected.

Injection

The 'Injection' field indicates if the injection process is fully functional (green), or if there is a fault (red).

Measurement system

The 'Measurement system' field indicates if the measurement system is fully functional (green), or if it has a fault (red). If a load curve is set (see B3.4 and B5.3.11), the injection process continues even if there is a measurement system fault.

Warning

This field is displayed when a warning is issued. The system continues running normally.

Measurement values

In the lower part of the overview screen, the current values (temperature, pressure, load, exhaust gas values, amount injected and reactant flow rate) are displayed.

6.2.3 'Dosage' screen

This screen is used for two purposes: firstly, it displays some of the current reactant dosage values; and secondly, it can be used to set parameters for the load curves and enable dosing values.

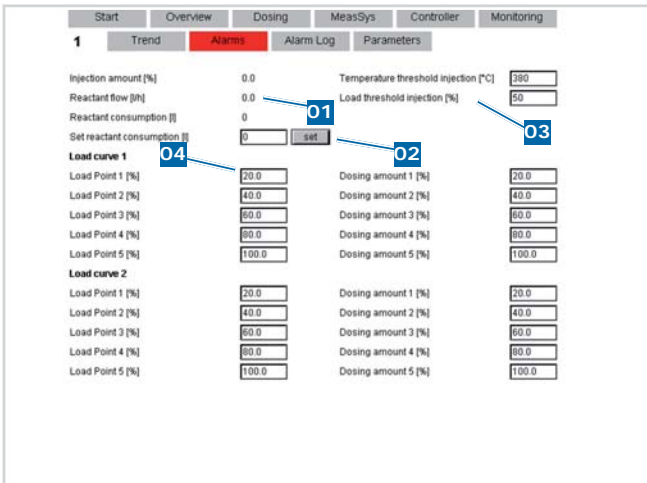

- 01 Current values
- 02 Alter reactant consumption
- 03 Parameter - enable injection
- 04 Parameters - load curves 1 and 2

Current values

The actual dosing values are displayed in the top left-hand part of the screen.

The table below explains the actual values:

Current values	
Designation	Meaning
Injection rate	Current injection rate in %
Flow rate	Current reactant flow rate in l/h
Consumption	Reactant consumption to date in l
Set consumption	Correction of the reactant consumption to date in l

Parameter - enable injection

The parameters for enabling reactant injection can be altered in the top right-hand part of the screen.

Temperature unit for enabling injection	Unit:	min.:	max.:
	°C	-	-

The condition for enabling the injection of reactant is fulfilled when the exhaust gas temperature measured at the converter outlet exceeds the parameterized value. If the value is below the entered value, no reactant is injected.

Load threshold unit for enabling injection	Unit:	min.:	max.:
	%	-	-

The load condition for enabling the injection of reactant is fulfilled when the exhaust-gas generator load exceeds the parameterized value. If the the value measured is below the entered value, no reactant is injected.

Load curves 1 and 2

In the bottom section, two load curves can be entered for two fuels, thus making control more precise. Thus, if a fault occurs in the measurement system, it remains possible to continue injecting reactant according to the selected load curve. A digital input can be used to select load curve 2.

▶ We strongly recommend that you parameterize a load curve to allow the system to continue injecting reactant if a fault occurs.

Load point x	Unit:	min.:	max.:
	%	-	-

It is possible to define five different load points for the exhaust gas generator on the load curve. A configurable reactant injection rate is allocated to each of these load points.

(→ Parameter - injection rate y)

Injection rate y	Unit:	min.:	max.:
	%	-	-

With this parameter it is possible to define the reactant injection rate for each respective load point.

(→ Parameter load point x)

Example:

X = load [%]

Y = injection rate [%]

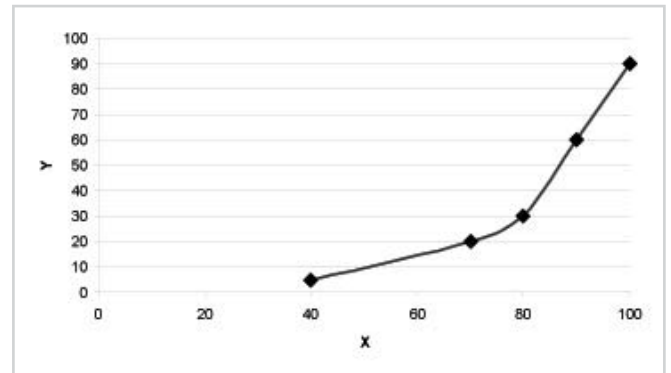

6.2.4 'Measurement system' screen

The 'Measurement system' screen visualises the current status of the measurement system.

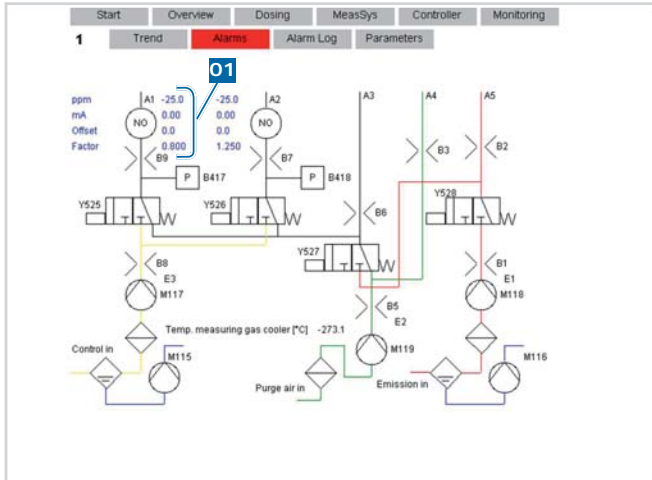

01 Current values

When pumps and valves are turned on their symbols are highlighted green.

If a pressure switch is highlighted green it means it has been actuated and that, consequently, the minimum gas flow has been exceeded.

Current values	
Designation	Meaning
ppm	Instantaneous measuring cell value in ppm
mA	Instantaneous output current of the measuring cell in mA
Offset	Deviation from the zero point of the measuring cell in ppm
Factor	Correction factor for compensating for the deviation between two measuring cells

Measuring system screen 2

This screen is only displayed if CO and/or NO₂ cells are activated.

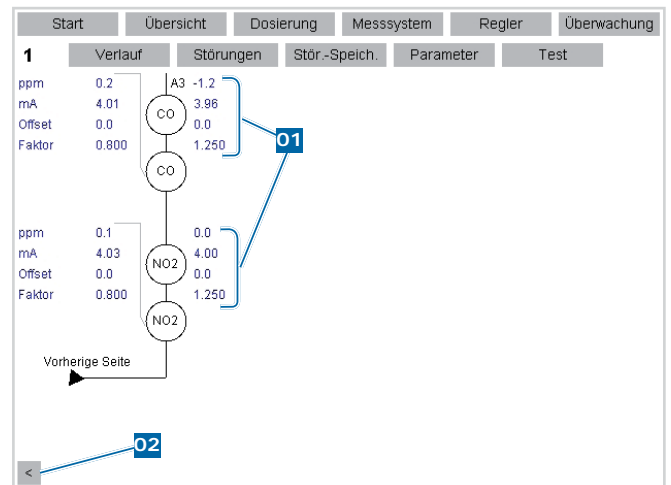

01 Current values

02 Scroll button (back)

6.2.5 'Controller' screen

The controller can be set on this screen and the history visually monitored in the graphic.

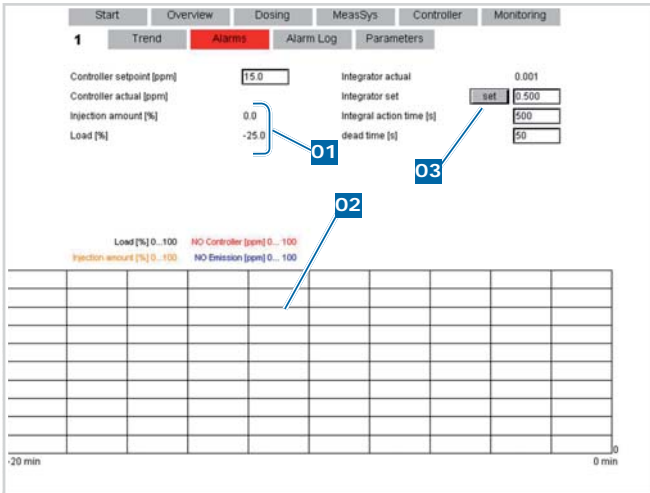

01 Actual controller values

02 History

03 Integrator values (actual)

Controller

Controller setpoint value	Unit: ppm	min.: -	max.: -
----------------------------------	---------------------	-------------------	-------------------

This parameter configures the value to be regulated.

Controller values	
Designation	Meaning
Actual controller value	Instantaneous actual controller value
Injection rate	This value corresponds to the integrator in percent if the load curve is deactivated. If an alternative load curve is used, this is overlaid with the integrator to give the effective injection rate in %
Load	Actual load of the exhaust gas generator in %

Integrator

Integrator values	
Designation	Meaning
Current integrator	Current integrator value With load curve: correcting factor on the curve Without load curve: direct valve opening
Set integrator	Correction of the integrator value to date

Adjustment time	Unit: s	min.: -	max.: -
------------------------	-------------------	-------------------	-------------------

The adjustment time defines the action of the integral controller. The longer the time, the smaller the adjustment steps of the controller.

Adjustment time: large adjustment step

Delay time	Unit: s	min.: -	max.: -
-------------------	-------------------	-------------------	-------------------

This time corresponds to the time interval after which changes are made to the controlled quantity. In this example the controller output and consequently the valve opening time is altered every 50 seconds. The greater the time selected the slower the controller reacts.

Delay time: interval between changes to the controlled quantity

(→ [Parameter list](#))

History

(→ [History \(measured data log\)](#))

6.2.6 'Monitoring' screen

All parameters for monitoring the exhaust gas purification system are displayed on this screen. ([→ Parameter list](#))

Start	Overview	Dosing	MeasSys	Controller	Monitoring
1	Trend	Alarms	Alarm Log	Parameters	
NO-Emission prealarm [ppm]	<input type="text" value="15"/>	Prealarm pressure converter [mbar]	<input type="text" value="30"/>		
NO-Emission alarm [ppm]	<input type="text" value="20"/>	Alarm pressure converter [mbar]	<input type="text" value="50"/>		
NO2-Emission prealarm [ppm]	<input type="text" value="15"/>	Prealarm temperature after conv. [°C]	<input type="text" value="490"/>		
NO2-Emission alarm [ppm]	<input type="text" value="20"/>	Alarm temperature after conv. [°C]	<input type="text" value="500"/>		
CO-Emission prealarm [ppm]	<input type="text" value="15"/>	Prealarm temperature in conv. [°C]	<input type="text" value="490"/>		
CO-Emission alarm [ppm]	<input type="text" value="20"/>	Alarm temperature in conv. [°C]	<input type="text" value="500"/>		
Controller setpoint line check [ppm]	<input type="text" value="150"/>				
Line check min. emission [ppm]	<input type="text" value="50"/>				
Emission line check start [ppm]	<input type="text" value="30"/>				

NO emissions pre-alarm	Unit:	min.:	max.:
	ppm	-	-

A fault is indicated if the nitrogen monoxide (NO) emissions exceed the parameterized value three times in succession.

NO emissions alarm	Unit:	min.:	max.:
	ppm	-	-

A fault is indicated if the nitrogen monoxide (NO) emissions exceed the parameterized value three times in succession.

NO ₂ emissions pre-alarm	Unit:	min.:	max.:
	ppm	-	-

A fault is indicated if the nitrogen dioxide (NO₂) emissions exceed the parameterized value three times in succession.

NO ₂ emissions alarm	Unit:	min.:	max.:
	ppm	-	-

A fault is indicated if the nitrogen dioxide (NO₂) emissions exceed the parameterized value three times in succession.

CO emissions pre-alarm	Unit:	min.:	max.:
	ppm	-	-

A fault is indicated if the carbon monoxide (CO) emissions exceed the parameterized value three times in succession.

CO emissions alarm	Unit:	min.:	max.:
	ppm	-	-

A fault is indicated if the carbon monoxide (CO) emissions exceed the parameterized value three times in succession.

Controller setpoint value - line monitoring	Unit:	min.:	max.:
	ppm	-	-

The value entered is affected when the line monitoring function is started.

Line monitoring - min. emissions	Unit:	min.:	max.:
	ppm	-	-

Line monitoring is triggered if the measured value falls below the parameterized value three times in succession.

Line monitoring start	Unit:	min.:	max.:
	ppm	-	-

Line monitoring is triggered if the measured value falls below the parameterized value three times in succession.

Pressure above converter pre-alarm	Unit:	min.:	max.:
	mbar	-	-

A fault is indicated if the pressure above the converter exceeds the parameterized value.

Pressure above converter alarm	Unit:	min.:	max.:
	mbar	-	-

A fault is indicated if the pressure above the converter exceeds the parameterized value.

Temperature downstream of converter pre-alarm	Unit:	min.:	max.:
	°C	-	-

A fault is indicated if the exhaust gas temperature measured downstream of the converter exceeds the parameterized value.

Temperature downstream of converter alarm	Unit:	min.:	max.:
	°C	-	-

A fault is indicated if the exhaust gas temperature measured downstream of the converter exceeds the parameterized value.

Temperature in converter pre-alarm	Unit:	min.:	max.:
	°C	-	-

A fault is indicated if the exhaust gas temperature measured in the converter exceeds the parameterized value.

Temperature in converter alarm	Unit:	min.:	max.:
	°C	-	-

A fault is indicated if the exhaust gas temperature measured in the converter exceeds the parameterized value.

6.2.7 'History' screen (measured data log)

On this screen it is possible to track the measured values. Use the buttons to navigate within the logged data.

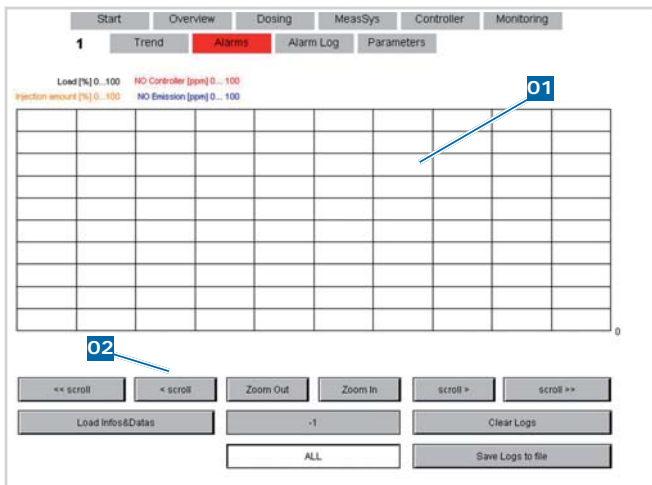

01 History

02 Navigation (history)

Navigation

Navigation	
Button	Meaning
<< scroll	Scroll back along the time axis in large steps
< scroll	Scroll back along the time axis in small steps
Zoom Out	Continuously increases the time interval displayed
Zoom In	Continuously decreases the time interval displayed
scroll >	Scroll forward along the time axis in small steps
scroll >>	Scroll forward along the time axis in large steps
Load Infos&Datas	Load data records
Save Logs to file	Save data record as .csv file

6.2.8 'Alarms' screen

All faults are displayed on these screens. Generated faults are highlighted red; select the respective fault to acknowledge.

If the scroll button is highlighted red, there is a fault displayed on the other page.

If a fault is still shown as unresolved after it has been acknowledged, it will remain highlighted in red, but with a black outline.

(→ Alarms operating manual)

Faults 1 screen

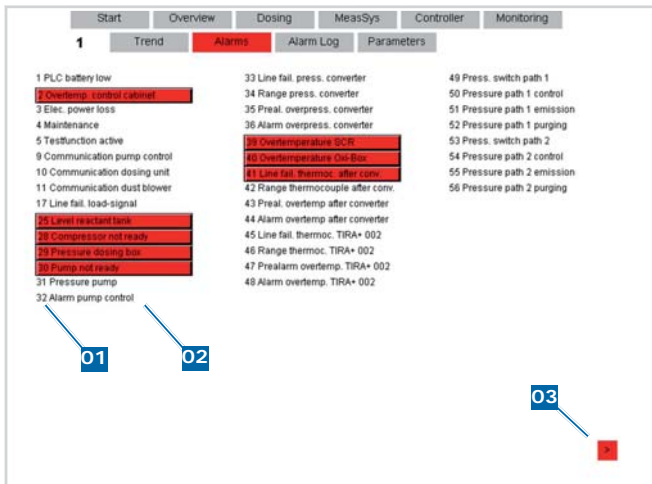

- 01 Fault number
- 02 Fault designation
- 03 Scroll button (forward)

Faults 2 screen

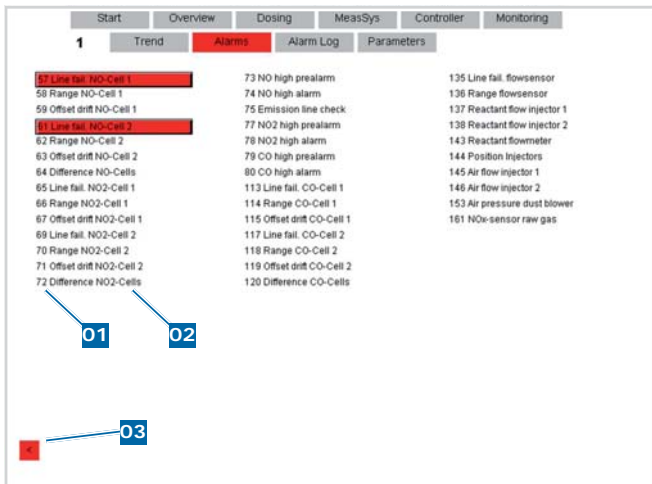

- 01 Fault number
- 02 Fault designation
- 03 Scroll button (back)

6.2.9 'Fault log' screen (fault log)

The last faults stored to memory are displayed on this screen.

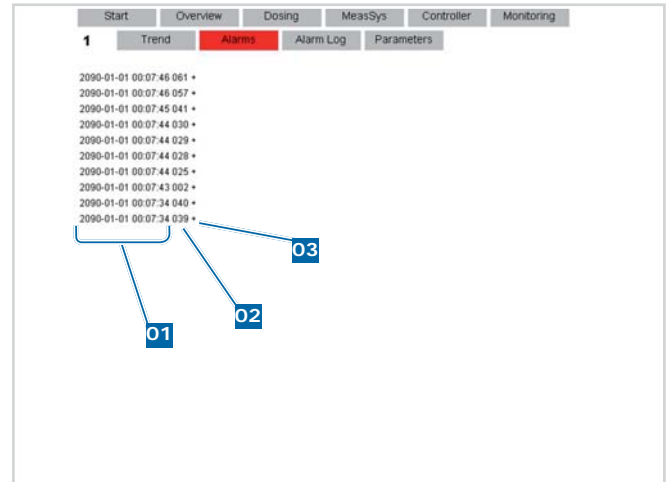

- 01 Time stamp
- 02 Fault number
- 03 Generation (+) / resolution (-) of fault

The stored faults are displayed with together with a time stamp and the fault number. In addition to this, a '+' or '-' sign is added to indicate 'generation' or 'resolution' of the fault.

6.2.10 'Parameters' screen

Set input values are contained in the parameter list. Actual input values must be adapted to suit the project. Generally speaking, the other parameters can be accepted and left unchanged. (→ [Parameter list](#))

Parameters screen 1 'General'

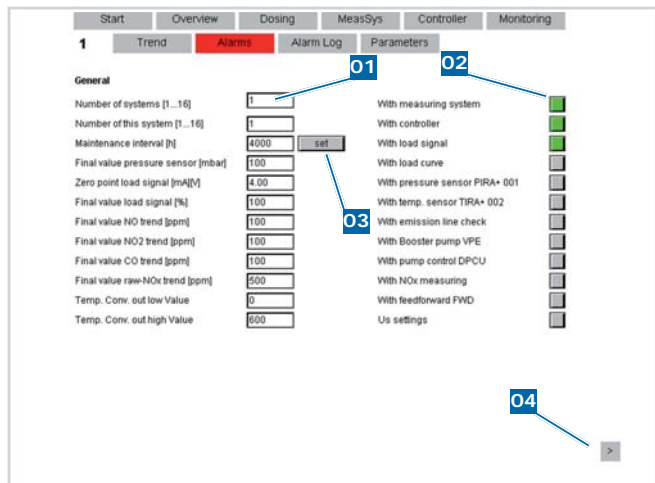

- 01 Input fields
- 02 Buttons
- 03 Reset maintenance interval
- 04 Scroll button (forward)

Input fields

Number of systems	Unit:	min.:	max.:
	Number	1	16

It is possible to integrate the control unit in a network comprising a maximum of 16 control units. Set this parameter to the total number of connected control units.

Number of this system	Unit:	min.:	max.:
	Number	1	16

Here, the number of the system you are trying to access must be defined. The number must be allocated only once within the network.

Maintenance interval	Unit:	min.:	max.:
	h	-	-

The value entered is the time until the fault Maintenance is indicated. After maintenance, the 'Set' button must be pressed in order to reset the interval.

Full scale value of pressure sensor	Unit:	min.:	max.:
	mbar	-	-

This is where the upper range limit is entered for the connected differential pressure transmitter in accordance with the data sheet.

Zero point load signal	Unit:	min.:	max.:
	mA, VDC	-	-

Enter the zero point of the load signal here. The signal is given in amps or volts, depending on the position of the jumper in the PLC. Example: 4 mA = 0% load.

Full scale value of load signal	Unit:	min.:	max.:
	%	-	-

This is where the upper range limit is entered for the load signal. The value is usually 100%, but can easily be adjusted.

Full scale value for trend tracks

The parameters of the full scale values: 'NO, NO2, CO and raw gas trend' define the range of the scales on the 'History' and 'Controller' screens.

Buttons

With measuring system	Unit:	min.:	max.:
	BIN	-	-

When a load curve is configured, this button can be used to switch off the measuring system. The injection rate is then defined only by the load and the current integrator.

With load signal	Unit:	min.:	max.:
	BIN	-	-

If the load signal for the reactant dosage needs to be taken into account, this button must be selected.

With load curve	Unit:	min.:	max.:
	BIN	-	-

If a load curve was recorded during commissioning, it can be taken into account by selecting this button. Controlling procedures are quicker and more exact when the load curve is activated; moreover, the exhaust gas purification system continues to operate should a fault occur in the measurement system.

With pressure sensor PIRA+001 (above converter)	Unit:	min.:	max.:
	BIN	-	-

Activate this button if a differential pressure transmitter has been installed. If the button is not activated, the differential pressure transmitter is not displayed in the visualization, and no data are recorded.

With temperature sensor TIRA+002 (in the converter)	Unit:	min.:	max.:
	BIN	-	-

Activate this button if a temperature sensor has been installed. If the button is not activated, the temperature sensor is not displayed in the visualization, and no data are recorded.

With line monitoring - emissions	Unit:	min.:	max.:
	BIN	-	-

Activate this button if the line monitoring function is to be enabled. If line monitoring is not activated, no fault will be indicated if a line ruptures or a leak occurs.

With reactant supply pump VPE	Unit:	min.:	max.:
	BIN	-	-

If a reactant supply pump (VPE) is installed, this button must be activate to ensure that dry running protection is active.

With pump controller DPCU	Unit:	min.:	max.:
	BIN	-	-

Activate this button if a pump controller DPCU has been installed.

With feed forward control FWD	Unit:	min.:	max.:
	BIN	-	-

If a the feed forward control unit with raw gas sensor is installed, this button must be activated.

Parameters screen 2 'Measuring system'

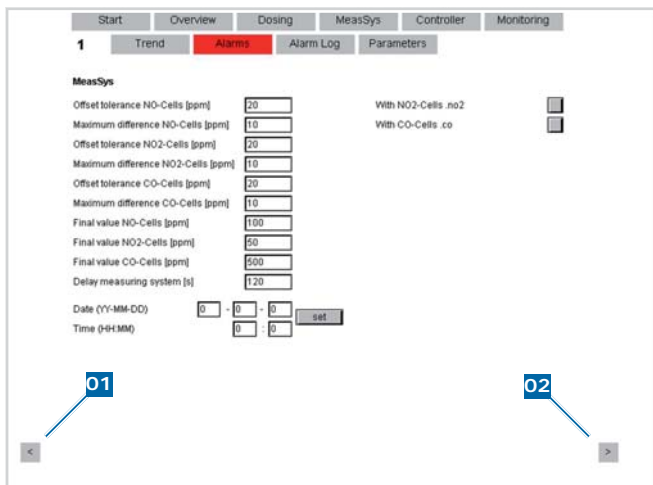

01 Scroll button (back)
02 Scroll button (forward)

Input fields

Zero point offset NO measuring cells	Unit: ppm	min.: -	max.: -
--------------------------------------	--------------	------------	------------

This value is used to set when a fault is output when the offset for the respective measuring cells is too large. The inspection takes place once after purging and once after recalibration of the measuring cells.

Maximum difference NO measuring cells	Unit: ppm	min.: -	max.: -
---------------------------------------	--------------	------------	------------

A fault is issued if the value entered here is exceeded when the measurement values of both measuring cells are compared.

Zero point offset NO ₂ measuring cells	Unit: ppm	min.: -	max.: -
---	--------------	------------	------------

This value is used to set when a fault is output when the offset for the respective measuring cells is too large. The inspection takes place once after purging and once after recalibration of the measuring cells.

Maximum difference NO ₂ measuring cells	Unit: ppm	min.: -	max.: -
--	--------------	------------	------------

A fault is issued if the value entered here is exceeded when the measurement values of both measuring cells are compared.

Zero point offset CO measuring cells	Unit: ppm	min.: -	max.: -
--------------------------------------	--------------	------------	------------

This value is used to set when a fault is output when the offset for the respective measuring cells is too large. The inspection takes place once after purging and once after recalibration of the measuring cells.

Maximum difference CO measuring cells	Unit: ppm	min.: -	max.: -
---------------------------------------	--------------	------------	------------

A fault is issued if the value entered here is exceeded when the measurement values of both measuring cells are compared.

Full-scale value CO measuring cells	Unit: ppm	min.: -	max.: -
-------------------------------------	--------------	------------	------------

This is where the upper range limit is entered for the connected measuring cell.

⚠ A measuring cell must never be subjected to a higher ppm value than the one entered here.

Full-scale value NO ₂ measuring cells	Unit: ppm	min.: -	max.: -
--	--------------	------------	------------

This is where the upper range limit is entered for the connected measuring cell.

⚠ A measuring cell must never be subjected to a higher ppm value than the one entered here.

Full-scale value CO measuring cells	Unit: ppm	min.: -	max.: -
-------------------------------------	--------------	------------	------------

This is where the upper range limit is entered for the connected measuring cell.

⚠ A measuring cell must never be subjected to a higher ppm value than the one entered here.

Delay measuring system	Unit: s	min.: -	max.: -
------------------------	------------	------------	------------

The value entered here is the time delay until the first measurement after the injection release has been reached.

Buttons

With NO ₂ measuring cells	Unit: BIN	min.: -	max.: -
--------------------------------------	--------------	------------	------------

If NO₂ measuring cells have been installed, this button must be selected so that measurement can be switched on.

With CO measuring cells	Unit: BIN	min.: -	max.: -
-------------------------	--------------	------------	------------

If CO measuring cells have been installed, this button must be selected so that measurement can be switched on.

Parameters screen 3 'Flow rate'

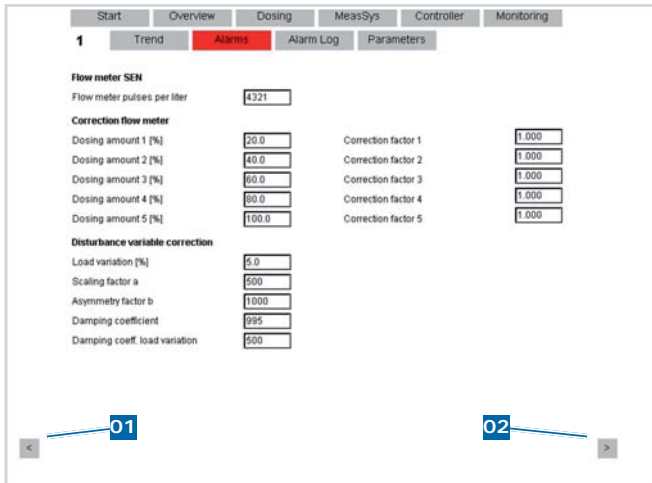

- 01 Scroll button (back)
- 02 Scroll button (forward)

Flow rate measurement SEN

Input field

Flow rate measurement	Unit: Pulse/l	min.: -	max.: -
-----------------------	------------------	------------	------------

The value entered here must be set based on the installed reactant dosing box SEN. The parameters are listed in the table below.

Parameter guide		
	Flow rate sensor	Pulse / Litre
SEN3	FHK3	7644
SEN6	FHK5	4321
SEN10	FHK10	2231
SEN20	FHK10	2231
SEN60	FHK20	995
SEN115	FHK25	715

Flow rate measurement correction

Input fields

Injection rate x	Unit: %	min.: -	max.: -
------------------	------------	------------	------------

Five different injection rates can be defined when correcting the injection rate. A parameterizable correction factor is assigned to these injection points.
(→ [Parameter guide table](#))

Correction factor x	Unit: -	min.: -	max.: -
---------------------	------------	------------	------------

The value to be entered here must be taken from the 'Parameter guide' table. This requires that the person making the entry knows if a reactant dosing box or a dosing system is connected. If a reactant dosing box is connected then the person making the entry must also know which type is installed.
The correction factors correct only the display.
(→ [Parameter guide table](#))

	Flow rate sensor	Correction values when control valve opens					
		10 [%]	20 [%]	40 [%]	60 [%]	80 [%]	100 [%]
SEN3	FHK3	0.911	0.97	1.052	1.047	1.047	1.054
SEN6	FHK5	0.63	0.715	0.826	0.901	0.956	0.998
SEN10	FHK10	0.471	0.593	0.752	0.862	0.923	0.976
SEN20	FHK10	0.571	0.685	0.837	0.905	0.987	1.037
SEN60	FHK20	0.447	0.633	0.807	0.912	0.958	1.028
SEN115	FHK25	1	0.684	0.823	0.943	0.943	1

Feed forward function

This function uses an NOx measurement in the exhaust directly downstream of the engine (raw gas) to directly influence the reactant injection. This enables immediate compensation for NOx fluctuations.
This optional function is primarily used for gas engines, when low NOx thresholds need to be observed.
This function can be switched on and off.

Input fields

The values to be entered here may only be altered by a specialist, and are described in more detail in the maintenance instructions.
(→ [Maintenance instructions](#))

Parameters screen 4 'Converter/dust blower'

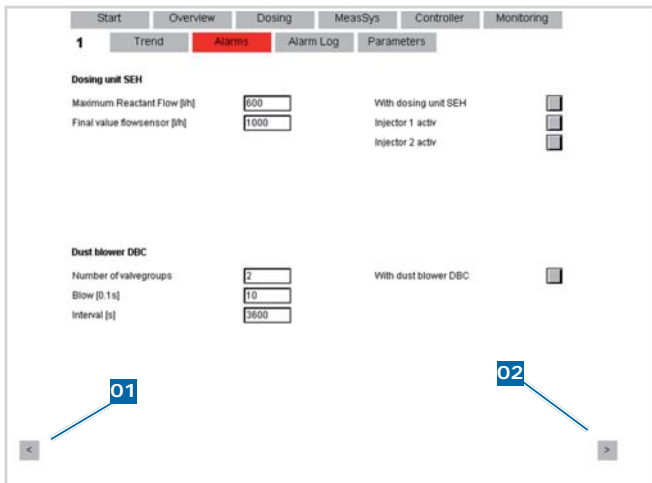

- 01 Scroll button (back)
- 02 Scroll button (forward)

Dosing system SEH

Input fields

Maximum flow rate	Unit:	min.:	max.:
	l/h	-	-

The maximum flow rate is the maximum permitted flow rate. For example, this may be restricted by the system (e.g. reactant nozzle) or the maximum reactant consumption.

▶ For multiple-nozzle systems, the maximum permitted flow rate is the total of all the installed reactant nozzles.

Full-scale value flow sensor	Unit:	min.:	max.:
	l/h	-	-

The set value matches the full-scale value for the standard installed flow rate sensor. The input field 'Full-scale value flow sensor 1000 [l/h]' corresponds to a signal current of 20 mA from the installed flow rate sensor.

Buttons

With dosing system SHE	Unit:	min.:	max.:
	BIN	-	-

If a reactant dosing system (SEH) is installed, this button must be activated.

Nozzle x active	Unit:	min.:	max.:
	BIN	-	-

Individual reactant nozzles can be activated and deactivated via the reactant dosing system. To enable a reactant nozzle, activate the respective button.

Dust blower DBC

Input fields

Number of valve groups	Unit:	min.:	max.:
	Number	-	-

This is where the number of installed valve groups (per tank) for the dust fan must be entered.

Blow cleaning	Unit:	Min.:	max.:
	0.1s	-	-

This value defines how long a blow-out pulse is to last. Example: When 5 is entered, this means an opening time of 0.5 seconds.

Interval	Unit:	min.:	max.:
	s	-	-

The value entered here is the time difference between two blow-out pulses.

Buttons

With dust blower	Unit:	min.:	max.:
	BIN	-	-

Activate this button if a dust blower has been installed.

Parameters screen 5 'Gas scrubber/analogue outputs'

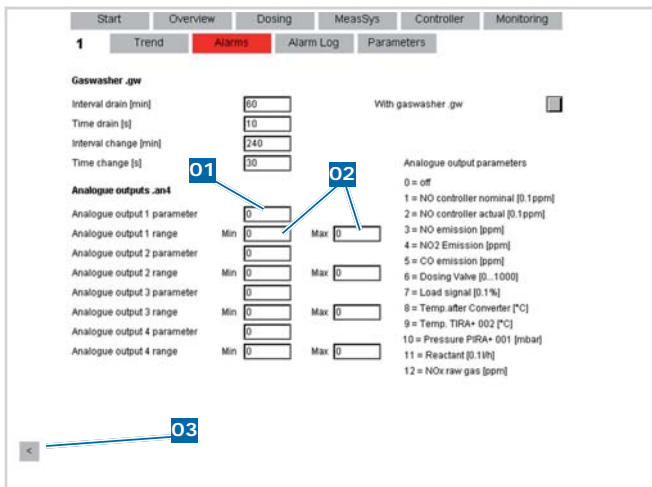

01 Parameters

02 Values for the range of the selected output signal

03 Scroll button (back)

Gas scrubber .gw

Input fields

Drain interval	Unit:	min.:	max.:
	min	-	-

Condensate from the sample gas lines results in the water level in the gas scrubber rising. That means that the water must be periodically brought down to the normal level. The value entered here is the time difference between two drainage procedures.

Drain duration	Unit:	min.:	max.:
	s	-	-

The value entered here is the time allotted for a drainage procedure.

Change interval	Unit:	min.:	max.:
	min	-	-

The soiled water must be replaced periodically. The value entered here is the time difference between two change procedures.

Change duration	Unit:	min.:	max.:
	s	-	-

The value entered here is the time allotted to change the water.

Buttons

With gas scrubber	Unit:	min.:	max.:
	BIN	-	-

Activate this button if a gas scrubber has been installed

Analogue outputs .an4

Input fields

Analogue output x parameters	Unit:	min.:	max.:
	-	-	-

Various output signals can be parameterized at the analogue output. The parameter entered here, as shown in the following table, defines the output signal.

Parameters	Signal	Unit
0	Switched off	-
1	NO controller setpoint	ppm
2	NO controller actual	ppm
3	NO emissions	ppm
4	NO ₂ emissions	ppm
5	CO emissions	ppm
6	Metering valve	%
7	Load signa	%
8	Exhaust gas temperature downstream of converter B605	°C
9	Exhaust gas temperature in the converter B604	°C
10	Pressure above converter B603	mbar
11	Reactant	l/h
12	NOx raw gas	ppm

Analogue output x range min	Unit:	min.:	max.:
	-	-	-

This is where the lower range limit is entered for the output signal.

Analogue output x range max	Unit:	min.:	max.:
	-	-	-

This is where the upper range limit is entered for the output signal.

7 Servicing

7.1 Repair / replacement

7.1.1 Replacing the sample gas filter / scavenging air filter

The sample gas and scavenging air filters are located on the swivel plate in the control unit. The filters are easily removed for replacement by unscrewing them. Replace all three filters at the same time.



01 Filter

7.1.2 Replacing the cooling air filter

The filters for the fresh air supply on the side of the control unit must be replaced regularly. The cover plate must be removed by pulling downwards. The filter to be replaced is located inside this.

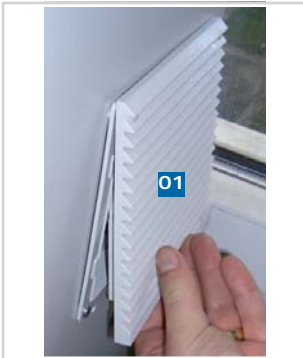

01 Cover plate



02 Filter